

Miniatur-Beschleunigungsaufnehmer Miniature Accelerometers

1.6.3
Sensoren
Sensors

NEU
NEW

KS96.10
KS96.100
KS97.10
KS97.100

Eigenschaften

- IEPE-Präzisionsaufnehmer mit Scherkeramik
- Besonders geeignet für Modal- und Strukturanalyse
- Einfache Befestigung durch Quaderform und M3-Gewinde
- Varianten mit vertikalem und horizontalem Ausgang
- TEDS

Properties

- IEPE precision accelerometers with shear ceramics
- Well suited for modal and structural analysis
- Easy mounting by cubic case with M3 thread
- Versions with vertical and horizontal outputs
- TEDS

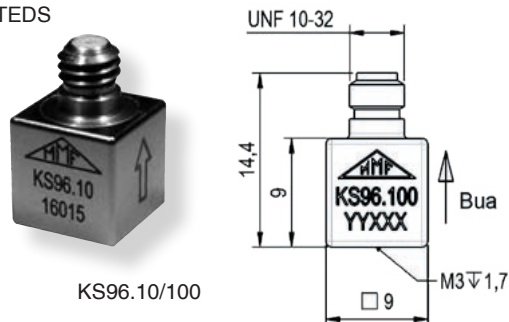

KS96.10/100

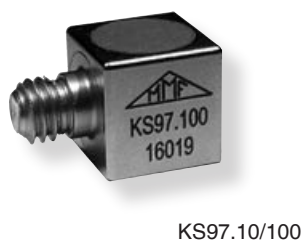

KS97.10/100

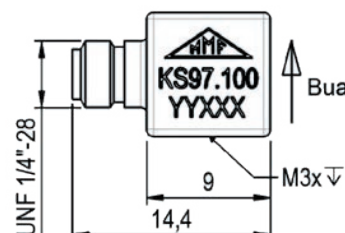

		KS96.10	KS96.100	KS97.10	KS97.100		
Ausgang • Output		IEPE	IEPE	IEPE	IEPE		
Piezosystem • Piezo design		Scherprinzip • Shear design					
Spannungsübertragungsfaktor • Voltage sensitivity	B_{ua}	10 ± 20 %	100 ± 20 %	10 ± 20 %	100 ± 20 %	mV/g	
Messbereich • Range	a_{+} / a_{-}	± 500	± 60	± 500	± 60	g	
Bruchbeschleunigung • Destruction limit	a_{max}	8000	8000	8000	8000	g	
Linearer Frequenzbereich • Linear frequency range	f_{3dB}	0,2-18k	0,15-13k	0,2-18k	0,15-13k	Hz	
	$f_{10\%}$	0,4-12k	0,3-7,5k	0,4-12k	0,3-7,5k	Hz	
	$f_{5\%}$	0,6-10,5k	0,45-6k	0,6-10,5k	0,45-6k	Hz	
Resonanzfrequenz • Resonant frequency	f_r	>46 (+25 dB)	>25 (+25 dB)	>46 (+25 dB)	>25 (+25 dB)	kHz	
Phasengang • Phase response	±5°	1,8-3,3k	1,4-3,3k	1,8-3,3k	1,4-3,3k	Hz	
Querrichtungsfaktor • Transverse sensitivity	Γ_{90MAX}	< 5	< 5	< 5	< 5	%	
Eigenrauschen (Effektivwert; 0,5 Hz - 20 kHz) • Residual noise (RMS; 0,5 Hz - 20 kHz)		$a_{n wide band}$	< 3000	< 400	< 3000	< 400	µg
Rauschdichten • Noise densities	0,1 Hz a_{n1}	200	30	200	30	µg/√Hz	
	1 Hz a_{n2}	80	8	80	8	µg/√Hz	
	10 Hz a_{n3}	30	3	30	3	µg/√Hz	
	100 Hz a_{n4}	8	0,8	8	0,8	µg/√Hz	
Nichtlinearität im Messbereich • Non-linearity for full range		THD	2	2	2	2	%
Konstantstromversorgung • Constant current supply		I_{CONST}	2 .. 20	2 .. 20	2 .. 20	2 .. 20	mA
Arbeitspunktspannung bei 25 °C • Output bias voltage at 25 °C		U_{BIAS}	12 .. 14,5	12 .. 14,5	12 .. 14,5	12 .. 14,5	V
Änderung bei T_{min}/T_{max} • Deviation for T_{min}/T_{max}			± 10	± 10	± 10	± 10	%
Ausgangsimpedanz • Output impedance		$I_{CONST} = 4 mA$ r_{OUT}	<100	<100	<100	<100	Ω
Elektronisches Datenblatt (TEDS) • Electronic data sheet (TEDS)		IEEE 1451.4; Template 25					
Verhalten gegenüber Umgebungseinflüssen • Environmental characteristics							
Arbeitstemperaturbereich • Operating temperature range		T_{min}/T_{max}	-40 / 120	-40 / 120	-40 / 120	-40 / 120	°C
Temperaturkoeffizient • Temperature coefficient		-40 .. 0 °C $TK(B_{ua})$	0,03	-0,03	0,03	-0,03	%/K
		0 .. 40 °C	±0,00	-0,06	±0,00	-0,06	
		40 .. 80 °C	-0,04	-0,08	-0,04	-0,08	
		80 .. 120 °C	-0,08	-0,11	-0,08	-0,11	
Temperatursprungempfindlichkeit • Temperature transient sensitivity		b_{aT}	1,5	0,3	1,5	0,3	ms ² /K
Magnetfeldempfindlichkeit • Magnetic field sensitivity		b_{aB}	4,5	0,5	4,5	0,5	ms ² /T
Mechanische Daten • Mechanical data							
Masse ohne Kabel • Weight without cable		m	2,4 / 0,085	3,2 / 0,11	2,4 / 0,085	3,2 / 0,11	g / oz
Gehäusematerial • Case material		Aluminium / Edelstahl • Aluminum / Stainless steel					
Kabelanschluss • Cable connection		axial		radial			
Buchse • Socket		UNF 10-32					
Befestigung • Mounting		M3-Bodengewinde • M3 thread in base					

Typischer Frequenz- und Phasengang Typical Amplitude and Phase Response

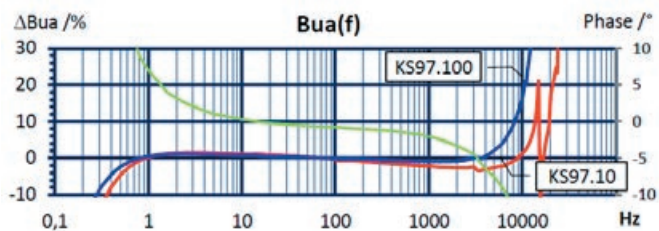
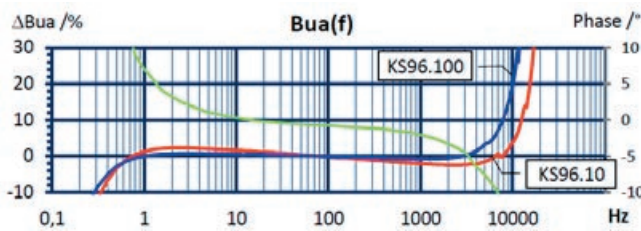

Temperaturverhalten Temperature Characteristics

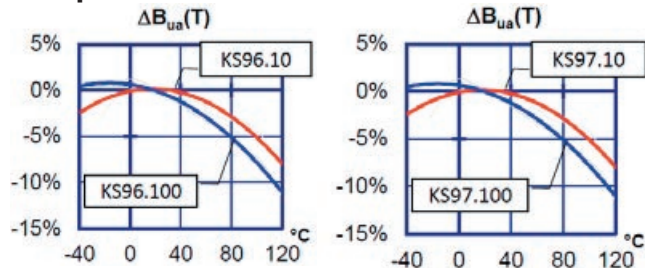

Rauschverhalten Noise Characteristics

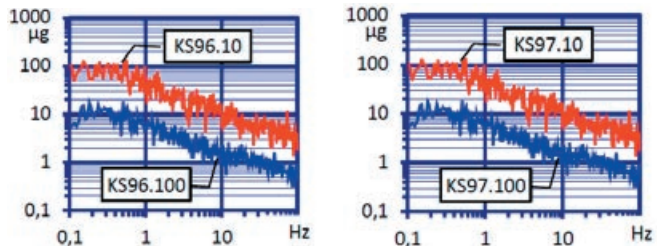

Passendes Zubehör • Suitable Accessories

Anschluss-zubehör	<ul style="list-style-type: none"> • 009-UNF-UNF-1,5: Störrames Kabel 2 x UNF 10-32; 1,5 m lang; 120 °C • 009-UNF-BNC-1,5: Störrames Kabel UNF 10-32 / BNC; 1,5 m lang; 120 °C • 010-UNF-BNC-5/10: Störrames UNF 10-32 / BNC; 5 / 10 m lang; 120 °C • 016: Kupplung für 2 UNF 10-32-Stecker • 017: Adapter UNF 10-32 / BNC (männlich) • 117: Adapter UNF 10-32 / BNC (weiblich) • 025: Adapter UNF 10-32 / TNC (männlich)
Connection accessories	<ul style="list-style-type: none"> • 009-UNF-UNF-1,5: Low noise cable 2 x UNF 10-32; 1.5 m long; 120 °C • 009-UNF-BNC-1,5: Low noise cable 2 x UNF 10-32 / BNC; 1.5 m long; 120 °C • 010-UNF-BNC-5/10: Low noise cable UNF 10-32 / BNC; 5 / 10 m long; 120 °C • 016: Coupler for 2 UNF 10-32 plugs • 017: Adapter UNF 10-32 / BNC (male) • 117: Adapter UNF 10-32 / BNC (female) • 025: Adapter UNF 10-32 / TNC (male)
Befestigungs-zubehör	<ul style="list-style-type: none"> • 021: Gewindestift M3 • 106: Isolierflansch M3 • 129: Isolierendes Klebepad M3 • 108: Haftmagnet M3
Mounting accessories	<ul style="list-style-type: none"> • 021: Mounting stud M3 • 106: Insulating flange M3 • 129: Insulating adhesive pad M3 • 108: Magnetic base M3

Bestellinformation • Ordering Information

KS96.xx/01, KS97.xx/01: Aufnehmer mit Zubehöretui; Inhalt: Kabel 009-UNF-BNC-1,5, Gewindestift 021, Klebewachs 002, Isolierflansch 106, Klebepad 129, Haftmagnet 108, Bedienungsanleitung, Kennblatt

Sensor with accessories kit including cable 009-UNF-BNC-1,5, mounting stud 021 adhesive wax 002, insulating flange 106, adhesive pad 129, magnetic base 108, instruction manual, data sheet

KS96xx; KS97xx: Aufnehmer mit Kennblatt
Sensor with data sheet

Hinweis: Auf Wunsch liefern wir unsere Aufnehmer mit einem kostengünstigen DKD-Kalibrierzertifikat. Preise auf Anfrage.

Note: Our transducers can be supplied with an attractively priced calibration certificate of DKD. Prices on demand.

Änderungen vorbehalten.

Specifications subject to change without prior notice.

Manfred Weber

Metra Meß- und Frequenztechnik in Radebeul e.K.

Meißner Str. 58

D-01445 Radebeul

Tel. +49-(0)351-836 2191

P.O.Box 01 01 13

D-01435 Radebeul

Fax: +49-(0)351-836 2940

Ausgabe / Edition: 10/16

Internet: www.MMF.de

Email: Info@MMF.de